

Enabling Technologies for Entrepreneurial Opportunities in 3D printing of SmallSats

Andrew Kwas
Northrop Grumman Technical Services
Albuquerque, NM, 505-998-8175
andrew.kwas@ngc.com

Eric MacDonald, Dan Muse, Ryan Wicker
University of Texas at El Paso, Keck Center
El Paso, TX, 915-747-6959
emac@utep.edu

Craig Kief, Jim Aarestad
COSMIAC
Albuquerque, NM, 505-934-1861
craig.kief@cosmiac.org

Mike Zemba, Bill Marshall, Carol Tolbert
NASA Glenn Research Center
Cleveland, OH, 216-433-5357
carol.m.tolbert@nasa.gov

Brett Connor
Youngstown State University
Youngstown, OH, 330-941-1731
bpconner@ysu.edu

ABSTRACT

A consortium of innovative experts in additive manufacturing (AM) comprising Northrop Grumman Technical Services, University of Texas at El Paso (UTEP), Configurable Space Microsystems Innovations & Applications Center (COSMIAC), NASA Glenn Research Center (GRC), and Youngstown State University, have made significant breakthroughs in the goal of creating the first complete 3D printed small satellite. Since AM machines are relatively inexpensive, this should lead to many entrepreneurial opportunities for the small satellite community. Our technology advancements are focused on the challenges of embedding key components within the structure of the article. We have demonstrated, using advanced fused deposition modeling techniques, complex geometric shapes which optimize the spacecraft design. The UTEP Keck Center has developed a method that interrupts the printing process to insert components into specific cavities, resulting in a spacecraft that has minimal internal space allocated for what traditionally were functional purposes. This allows us to increase experiment and instrument capability by provided added volume in a confined small satellite space.

Leveraging initial progress made on a NASA contract, the team investigated the potential of new materials that exploit the AM process, producing candidate compositions that exceed the capabilities of traditional materials. These “new materials” being produced and tested include some that have improved radiation shielding, increased permeability, enhanced thermal properties, better conductive properties, and increased structural performance. The team also investigated materials that were previously not possible to be made. Our testing included standard mechanical tests such as vibration, tensile, thermal cycling, and impact resistance as well as radiation and electromagnetic tests. The initial results of these products and their performance will be presented and compared with standard properties. The new materials with the highest probability to disrupt the future of small satellite systems by driving down costs will be highlighted, in conjunction with the electronic embedding process.

INTRODUCTION AND DESCRIPTION OF THE EFFORT

Technology is constantly changing. What not long ago was modern technology is quickly becoming obsolete. VCR cassettes were replaced by DVDs that are now being replaced with digit downloads and streaming media. The small-satellite market, driven by disaggregation initiatives, is increasingly filling many traditional large-satellite missions. Now small satellites, already a fraction of the cost of large ones, are getting even more affordable. A major contributor is the application of additive manufacturing (AM) to the small-satellite market that holds promise to readily make them for any application at reduced cost and schedule.

A team formed to conduct activities for GRC and America Makes has been working on combining AM advanced technologies to make the goal of affordable small satellites a reality. This team includes Northrop Grumman Technical Services, providing satellite experience; University of Texas-El Paso (UTEP) W.M. Keck Center for 3D Innovation and Youngstown State University (YSU), universities with advanced AM capability; Configurable Space Microsystems Innovations & Applications Center (COSMIAC), a university affiliate with small satellite innovation techniques; and GRC, providing oversight and technical support.

Most people think AM is limited to improving manufacturing processes for piece parts or brackets. Our team is taking it to the next step by embedding components of a small satellite into the walls of the article, with the ultimate goal of producing an “empty” flight-ready system. This will maximize the available internal space for instrumentation, sensors and experiments and result in an even smaller, more efficient carrier vehicle. Key members of the Manufacturing Demonstration Facility (MDF) at Oak Ridge National Laboratory (ORNL) highlighted last year that, “The introduction of additive manufacturing to the small satellite community has opened up exciting new opportunities for the design and rapid, low cost fabrication of multifunction structures.”¹ MDF focus has been on electron beam melting of titanium powder to form a 3U CubeSat. Their work was successful in developing a notional concept which used integral propulsion and thermal management systems in the metal structure. The limitation of this concept due to the high temperatures associated with printing metals is the inability to embed the wiring and electronics directly into the base material. ORNL correctly stated in an AIAA Space Proceeding, that the use of embedded systems in structures “could reduce the volume and

mass of a spacecraft by approximately 80% to 90%, respectively, and decrease the assembly and rework labor by 50%.”² With disruptive innovation potential on that order, the growth of small satellites through the use of additive manufacturing is assured.

Instead of metal structures, our approach exploits the advantages of building the structure with thermoplastics (Fig. 1). Previous prototypes have used thermoplastics to build basic models of satellites for form and fit checks, so the basic process is proven. The

uncertainty, however, is whether thermoplastics can be used for flight assets that require high strength, radiation shielding, and thermal management—all nontrivial considerations for nonmetallic structures. These technical challenges may be more complex because of the material choices as noted in the next section, but the advantages that AM offers are significant. These include building the satellite with minimal tooling, low-cost base materials, and automated design tools to create easily modifiable STL (computer-aided design, or CAD) files. We proposed that the use of advanced base materials such as polycarbonate, ULTEM and others, could lead to disruptive advancements in small satellites by driving down costs, fabrication time, design complexity, and most importantly internal space required for the components and circuitry necessary to operate the spacecraft.

Small satellites have distinct advantages for the operational application of ever-growing satellite missions. They are typically less expensive to build and have reduced schedules to design, build, and test. This results in the further benefits of enabling development cycles inside adversary loops, lower costs for access to space, capability of formation flying of clusters (or swarms) for improved time on target, and increased mission resilience if lost because of malfunction or adversary attack.



Figure 1. 3D-printed polymer 3U CubeSat.

Industry has acknowledged that small-satellite costs are already “in the zone” for most operational and research and development (R&D) applications, though with improvements and miniaturization of components, we see costs being reduced further. The biggest challenge with small satellites is that precious internal volume is usually taken up with wires and components as shown in our partner COSMIAC’s Trailblazer 2U CubeSat (Fig. 2). Led by our UTEP partner, the Keck Center has developed a process to stop printing and insert wires and circuitry within the satellite structural walls (Fig. 3).

Successful results do not come without challenges. The team is working on several of these technical hurdles, as noted below.

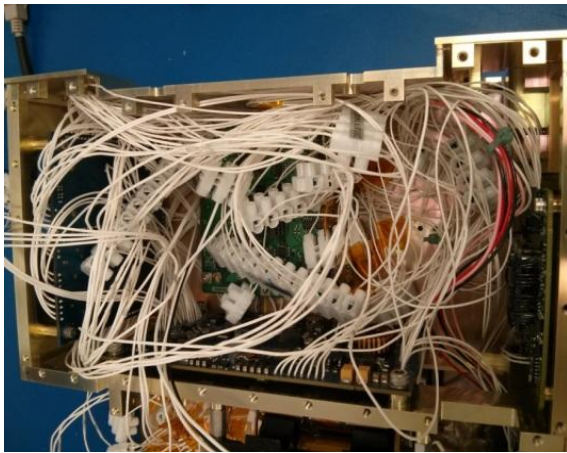

Figure 2. Trailblazer 2U CubeSat.

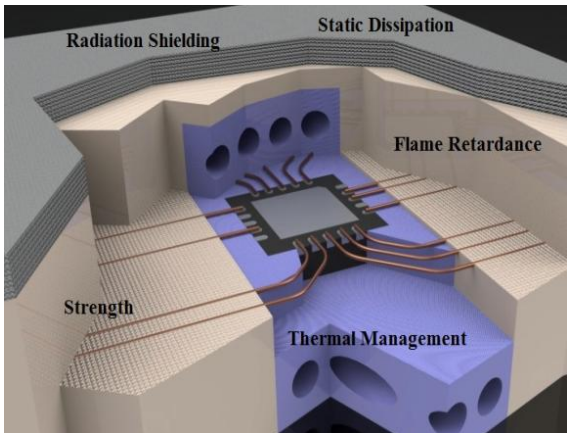

Figure 3. UTEP embedded electronics feature.

TECHNICAL CHALLENGES AND PROGRESS

Candidate material selection

Additive manufacturing is still in its infancy with respect to optimizing materials for space-related

environments and applications. We proposed 17 candidate AM materials for investigation as shown in Table 1. Some industry baseline materials are included in the assessment, like acrylonitrile-butadiene-styrene (ABS), but some more advanced candidates are also being considered. The effort by the team is not trivial, because building the optimal small satellite requires not just printing a simple material. Key technical challenges are to be printable with embedded electronics, have the necessary dielectric, conductive, and radiation shielding properties, and still be structurally sound.

Table 1. Candidate Materials

Candidate Materials*		
CaTiO ₃	Tungsten (W)	Nylon
SrTiO ₃	ABS/UHMWPE	ABS ESD
TiO ₂ , anatase	ABS/HDPE	Zeonex
TiO ₂	ULTEM	Thermally Conductive PC
NaCl	PC	Polyimide
Fe ₃ O ₄	PC-ABS	

*UHMWPE is ultrahigh molecular weight polyethylene; ESD, electrostatic dissipative; HDPE, high-density polyethylene; and PC, polycarbonate.

Sensor embedding process

Components with different material composition and packaging can be integrated into a three-dimensional-(3D) printed structure. To illustrate relevant possibilities, we demonstrated this using accelerometers from Dytran shown in Figure 4. The 3D printing process used fused deposition modeling (FDM), a thermoplastic extrusion-based additive manufacturing method that shows the most promise in creating functional 3D-printed devices.



Figure 4. Dytran accelerometers used in the demonstration.

Figure 4 shows the sensors used in this demonstration. Three types of sensors were chosen to illustrate the possibility of accommodating multiple form factors. A simple substrate was designed to house the sensors. For simplicity, the substrate in this example is planar, but the design can be far more complex and can be adapted

to suit the needs of a particular application. For this demonstration, it was desired to access the sensors via connectors located on the exterior surfaces of the substrate. Figure 5 illustrates the substrate with cavities designed to house the three sensors and connectors as applicable. Sensor assemblies that include an integral multi-filament cable for power, communications, or raw sensor output can be integrated as shown in the figure. Cavities are designed to allow a press fit for the sensors, wiring, and connectors. For larger components, it is beneficial to design a 3D-printed ‘cap’ for covering the components after insertion into the substrate. This allows additional material to be easily deposited in subsequent layers above the components. Successful layered printing requires a good interlayer bond. The cap, printed with the same material as the substrate, facilitates bonding, whereas printing directly onto a metal component, for example, would generally result in print failure. It has been observed that small gaps or openings do not hinder subsequent printing and therefore do not require a cap. For the sensors used in this demonstration, the caps also allow for better packaging of the connectors at exterior surfaces of the device. The caps are further useful in protecting sensitive components from extrusion temperatures, which could be problematic if printing directly onto the components. Extrusion temperatures are typically much higher than envelope or substrate temperatures during the printing process. Use of caps extends the range of components that are compatible with this process.

The process for printing the sensor device is illustrated in Figure 6. The 3D design is prepared for printing and loaded into the FDM machine (a Fortus 400MC in this example). The build file includes a ‘pause’ to allow

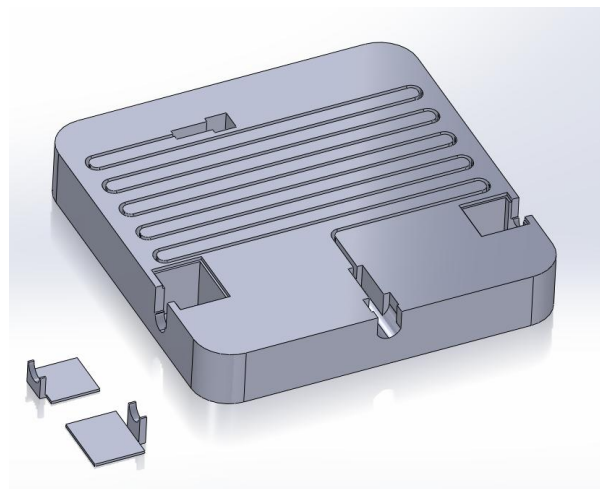

Figure 5. 3D model of sensor substrate, showing cavities for housing the accelerometers, connectors, and sensor wiring.



Figure 6. In-process images of sensor demonstration build. (a) Substrate printed up to component insertion point and sensors installed.



(b) 3D-printed caps installed above larger sensors.



(c) Final layers printed above sensors to complete the piece.

process intervention. Figure 6(a) shows the substrate printed up to the pause layer. The component cavities are fully formed, and the components are placed. For this example, the substrate was left in the FDM machine, and the components were pressed into place *in situ*. More complex devices may require removal of the substrate from the FDM machine to allow additional process steps to be completed, such as thermal wire or mesh embedding, prior to returning to the printing process. Having inserted the components, the protective caps are installed above the larger sensors as shown in Figure 6(b). Once inspection is complete, the printing process is resumed and the final covering layers are deposited above the sensors to complete the device shown in Figure 6(c).

Figure 7 shows the device after removal from the FDM machine and cooling. Although this demonstration is simple and has not been optimized, it does provide insight into the possibilities for creating highly functional and volumetrically complex devices using commercially available components and 3D printing technology.

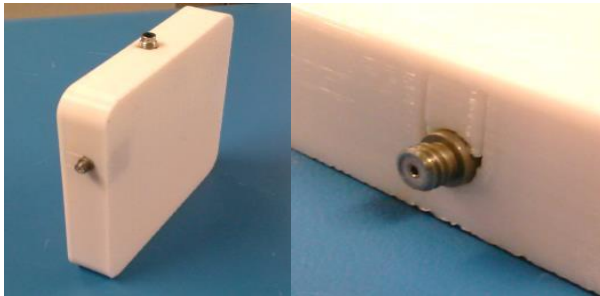

Figure 7. Completed part and close-up view of embedded sensor with exterior connector access.

A similar process was used by UTEP to “attach” standard solar panel coverglass interconnected cells (CICs) in a 3U CubeSat prototype as seen in Figures 8(a) and (b). A series-parallel configuration of solar CIC modules was chosen to provide the desired voltage and current range for charging an onboard battery. As a result, the addition of blocking (isolation) diodes was necessary. The cavities shown in the 3D model of the CubeSat structure depicted in Figure 8(a) were designed to allow a press fit of the diodes and the CICs. Prior to installing the CIC modules and diodes, copper wire was routed from the cavities to the CubeSat’s power bus using an automated ultrasonic wire-embedding process. The CICs and diodes were then soldered together and joined to the copper wire before being pressed in place as shown in Figure 8(b). A flight-ready implementation would likely include an additional step whereby additional material is deposited (printed) above the embedded wire and around the

periphery of the CIC modules to better secure them in the structure. In a fully automated process, soldering could be replaced with laser microwelding to create reliable and repeatable conductor joints. This example further illustrates the possibility of integrating components of arbitrary form-factor into a 3D-printed structure.

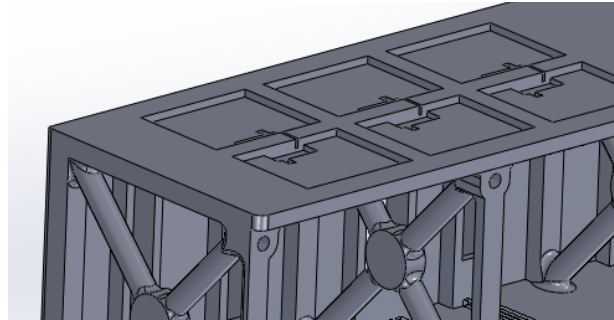

Figure 8(a). Component cavities designed to house multiple solar CIC modules and isolation diodes.

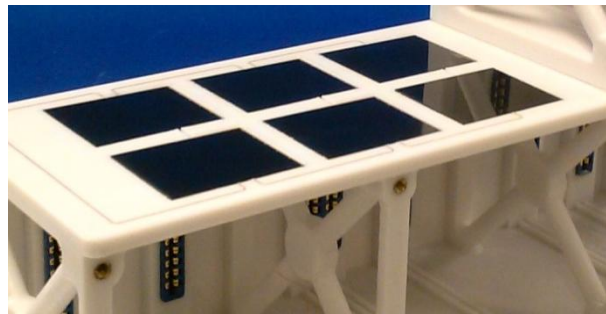

Figure 8(b). Completed 3U CubeSat prototype with embedded copper wire connecting a solar CIC array to the power bus.

Communication Systems

As part of the initial research in implementing communications in an additive manufactured SmallSat structure, the team created a series of independent 3D-printed panels (Fig. 9) that, when in close proximity to each other, automatically form a mesh network in the shape of a 1U CubeSat (Fig. 10). The design for this mesh network is based on the Atmel radiofrequency (RF) development board system. Each panel houses its own battery, solar panel, and custom circuitry to complete a specific function. Once powered, the panels will dynamically build a network to pass data. This wireless technology is built on the Zigbee automation protocol standard 802.15. Our team was able to ensure that the system worked properly, develop the required software, and characterized the complete schematic.

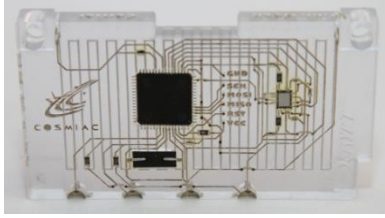

Figure 9. 3D-printed circuit board.

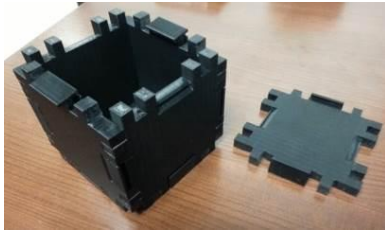

Figure 10. Six panels form 1U CubeSat.

Antenna Design and Characterization

Directly related to the communication system is our work to investigate printing the antennas into the walls of the spacecraft for downlink to the ground and for space-to-space communications. Multiple iterations of antenna designs are planned to demonstrate the additive manufacturing of various designs and to identify areas where AM may improve the implementation in terms of performance, customizability, and/or cost. The first of these concepts fabricated and tested, shown in Figure 11, is a two-arm Archimedean spiral, which has the advantage of being low-profile, wide-band, and inherently circularly polarized. The spiral was selected as the first iteration design for these characteristics given their relevance to SmallSat applications, and its ease in printing on the SmallSat surface.



Figure 11. An embedded two-arm Archimedean spiral.

The antenna was designed with CST Microwave Studio (CST Computer Simulation Technology AG) and fabricated by printing a 10-cm by 10-cm by 0.6-cm polycarbonate plate, after which the two arms of the spiral were introduced by embedding wire into the plastic. A shape memory alloy (SMA) connector and ground plane were added manually but are targets for future automated fabrication or embedding through AM processes. The fundamental design parameters of an Archimedean spiral are the inner and outer circumference (which define the frequency band), the number of turns (or flare rate) of the spiral, and the feed structure, all of which are easily configurable through the above-described printing process for new applications or multiple iterations of a design. The antenna was characterized at Glenn Research Center (Fig. 12) in terms of return loss, far-field pattern, and co- and cross-polarization. Figure 13 shows a preliminary characterization of the far-field pattern measured at 4 GHz. Although initial test results agreed with simulations, the frequency independence of the antenna within the designed band was limited because of interfering reflections from the ground plane and impedance mismatches. Testing identified areas where subsequent designs can use printable conductive materials and dielectric substrates. These techniques will minimize interfering reflections from the ground plane while maintaining a slim profile and developing a printable balun for impedance matching that is integrated into the printed design. Future designs of interest include patch antennas for their prevalence in SmallSat applications and fractal antennas for their wide-band characteristics and potential for novel AM implementations.



Figure 12. The printed spiral undergoing pattern measurement in the far-field antenna range at NASA Glenn Research Center.

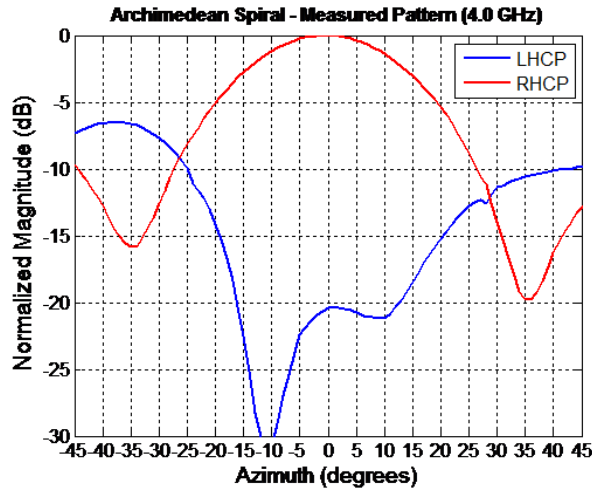

Figure 13. Measured co- and cross-polarization patterns of the spiral at 4 GHz.

Incorporating Propulsion systems

To date, most CubeSat systems that have flown either do not include propulsion systems or only include simplified types of cold-gas or solid-propellant systems.³ To support operational missions, there is an interest in being able to expand the useful capabilities of CubeSats beyond free-floating payloads. A large focus recently has centered on developing advanced micropropulsion systems that would be ideally suited for small satellite- and nanosatellite- (CubeSats) class systems.^{3,4} In conjunction with these efforts are investigations to determine how additive manufacturing techniques can be utilized to include propulsion components and concepts.³ Additive manufacturing provides an opportunity to package propulsion systems in unique ways that can minimize mass and optimize the utilization of space within a CubeSat module. Work is being conducted independently at NASA Glenn Research Center and Northrop Grumman to study the ability to incorporate propulsion systems into a printed SmallSat structure. This will include investigating whether propulsion system components can be effectively printed or embedded into materials, determining material compatibility with candidate propellants, and assessing mission concepts that would benefit from inclusion of propulsion systems. A representative model cold-gas system is also planned to be developed as part of this effort.

Radiation shielding

Mitigation of radiation effects on small-satellite electronic systems is typically accomplished in two ways: (1) Use of space-rated, space-qualified parts and (2) Use of shielding material to block or attenuate radiation reaching electronic components.

Electronic parts hardened to radiation or immune to its effects are more expensive than commercially available equivalent parts, often by orders of magnitude. With affordability a major factor of our work, off-the-shelf radiation-hardened parts were not considered. Such parts also require long lead times and impose penalties in inventory and storage costs.

Shielding is a valid, if somewhat less effective, method of reducing radiation effects. However, the level of protection that traditional shielding offers is related to the thickness of the shielding material. Therefore, increased shielding results in increased mass, reduced interior dimensions of the spacecraft, and increased cost of materials and construction. Additionally, in the low-Earth orbits at which SmallSats are typically flown, the radiation environment is normally characterized by atomic particle radiation (protons, neutrons, and electrons) from solar activity rather than from the much higher energy, more destructive radiation caused by galactic cosmic ray (GCR) particles.

The use of AM for construction of spacecraft structural components has emerged as an attractive alternative to more traditional, milled aluminum construction for several reasons. The atomic mass of the materials used for construction plays an important role in determining that material's shielding capabilities, with 1) low-Z materials such as thermoplastics capturing large particles such as protons and neutrons and 2) high-Z materials, such as tungsten or tantalum, absorbing electron energies.

AM offers two techniques for combining materials to take advantage of their combined properties: (1) changing materials during printing for a layered effect, and (2) creating new filament stock by combining materials into a hybrid source of material. Both these techniques can be used to create structural components that optimize radiation shielding effects. The challenge is whether or not the "new" materials can even be printed, and if they can, will the resulting properties perform as expected? In order to gain a better understanding of the radiation shielding provided by printed construction materials, we manufactured CubeSat class panels with a variety of materials and performed low-energy X-ray testing on each. The list of candidate materials appears earlier in Table 1.

The initial testing was performed on May 6, 2014 with a second series on June 6th, at Kirtland Air Force Base (KAFB). The Keck Center printed panels for this initial round of testing using the materials listed in Table 2 with the addition of Polycarbonate samples with varying levels of tungsten for round two.

Table 2. Tested Materials and Their Properties

Material	Abbr.	Advantages
Polycarbonate	PC	Good tensile strength
ULTEM	ULTEM	Best tensile strength
Polycarbonate – acrylonitrile butadiene styrene	PC-ABS	High printing resolution
Conductive polycarbonate	PC-ESD	Electrostatic discharge
Nylon	Nylon	Chemical resistance, Mechanical strength
Acrylonitrile butadiene styrene with 2% tungsten	ABS-W2%	Improved radiation shielding
Acrylonitrile butadiene styrene, 75% with UHMWPE, 25%	ABS/ UHMWPE	Improved radiation shielding

Results of Radiation Shielding Testing

Radiation testing of the panels was performed at the Low-Energy X-Ray Source (LEXR) on KAFB. This small test facility is used for radiation hardness testing of chips, die, boards, and components, and is capable of delivering high total ionizing dose (TID) rates of more than 3 MRads/hour, providing rapid evaluation of device-under-test (DUT) radiation tolerances.

Data from the testing is summarized in Figure 14. As expected for the materials tested, tungsten-impregnated samples provided the greatest shielding improvement, ULTEM and polycarbonate performed well, and ABS/UHMWPE resulted in minimal shielding

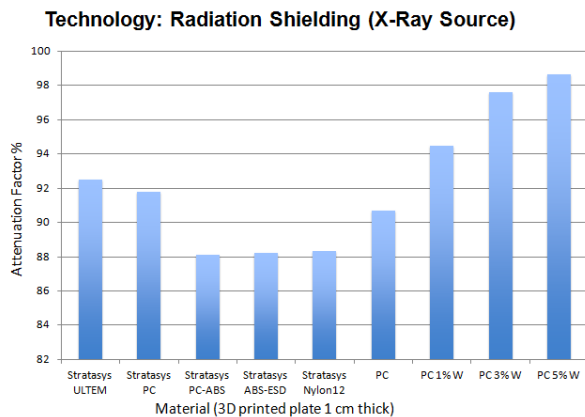

Figure 14. Test results of selected materials

Thermal management

3D printing can provide innovative active thermal management solutions for terrestrial or space applications. For automotive applications, heat exchangers are assembled from aluminum brazing sheet and fin stock (sheet or extrusions) and use convection and conductivity to remove heat from the system. The geometry of a heat exchanger is well recognized by anyone who has peered through the grill of a car, and that geometry is limited by the manufacturing methods

described above. One of the key attributes of 3D printing is that geometric complexity is free (i.e., the cost to fabricate is the same regardless of complexity) and therefore can be used to optimize the functionality of the part. For example, 3T RPD and Within Labs designed a heat exchanger and fabricated it using direct metal laser sintering (DMLS).⁵ The geometry is a significant departure from the traditional heat exchanger with an organic external appearance and internal turbulent producing stators to improve cooling.

For space systems, the vacuum prevents use of convection, so the only way to remove heat is through radiation. Without thermal management, the solar-exposed portion of a space vehicle would reach temperatures up to 250 °F (121 °C), while thermometers on the dark side would plunge to -250 °F (-157 °C).⁶ On platforms such as the space shuttle and the International Space Station, heat rejection uses radiator panels deployed from the vehicle and oriented away from direct solar radiation. The radiation behavior is governed by the Stefan-Boltzmann Law. The amount of energy that can be radiated from a body is directly proportional to the area of the radiating surface. The Stefan-Boltzmann Law also informs us that low-temperature heat rejection requires an even larger radiating surface than at higher temperatures.⁷

Finding surface area on a small satellite such as a 3U CubeSat for thermal radiation is a challenge since a radiator panel competes for space with solar arrays and RF antennas. As noted above for larger platforms, deployable panels are one approach. Additionally, one can take advantage of 3D printing to fabricate surface topologies into the radiating panel to increase the surface area of the panel. Further, addition of heat pipes embedded into the vehicle structure can be accomplished just as the RF antennas and other devices shown in this paper were, though fluid options are limited for thermoplastics.

YSU has received a gift of Siemens PLM Software from Siemens Corporation that includes the NX Space Systems Thermal suite. This will be used by YSU students to design the thermal management system.

Modeling and simulation will help guide an iterative design process involving fabrication of physical prototypes, testing, model verification, optimizing redesign, and retesting until a final design is obtained.

The Multi^{3D} printing and fabrication system will use FDM to print the CubeSat structures using polymers such as PC and ULTEM 9085, which are thermal insulators. For our application, we desire materials that are thermally conductive but also electrically insulating. This is where our teammate rp+m is engaged. rp+m is a company involved in 3D printing manufacturing as well as materials and process development. They have developed processes involving loading FDM-capable polymers with other materials to make composites that achieve the desired thermal, electrical, and mechanical properties. One material to be evaluated is ULTEM 9085 loaded with carbon fiber (CF). Examples of ULTEM 9085/CF composite structures printed using FDM are shown in Figure 15. Polycarbonate (PC) loaded with boron nitride (BN) will also be evaluated.

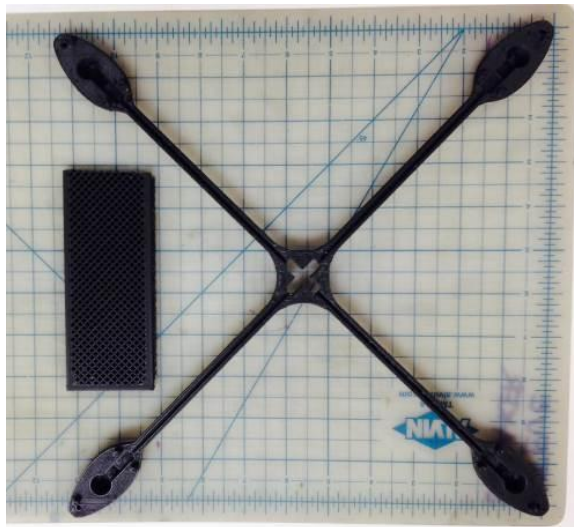

Figure 15. ULTEM 9085/CF composite structural frame and lattice printed using FDM.

The Future - Multi^{3D} Manufacturing for Satellites

The next generation of manufacturing technology for space hardware will require complete spatial control of material and functionality as structures are created layer by layer—providing fully customizable, high-value, multifunctional products for aerospace industries. Utilizing an America Makes grant, contemporary AM is being integrated seamlessly by the team with a suite of comprehensive manufacturing technologies, including (1) extrusion of a wide variety of robust thermoplastics/metals, (2) micromachining, (3) laser ablation, (4) embedding of wires and fine-pitch meshes

submerged within the thermoplastics, and (5) robotic component placement. Collectively, the integrated technologies will fabricate *multi-material* structures through the integration of multiple integrated manufacturing systems (*multi-technology*) to provide *multifunctional* products. A prototype version of the proposed system has been created at UTEP (Fig. 16(a)) and includes several sub-processes with a conveyance system to translate a device-under-construction between manufacturing stages. The prototype is capable of embedding wires and components within a multi-material substrate to provide mechanical, electronic, thermal and electromagnetic functionality. Although this technology is well suited for fabricating satellite hardware where the harsh conditions of space provide a testament to the robustness of the resulting structures, the proposed Multi^{3D} Manufacturing System (Fig.16(b)) can also be used to fabricate any 3D structural electronics including those intended for use in consumer, biomedical, aerospace, or defense markets.

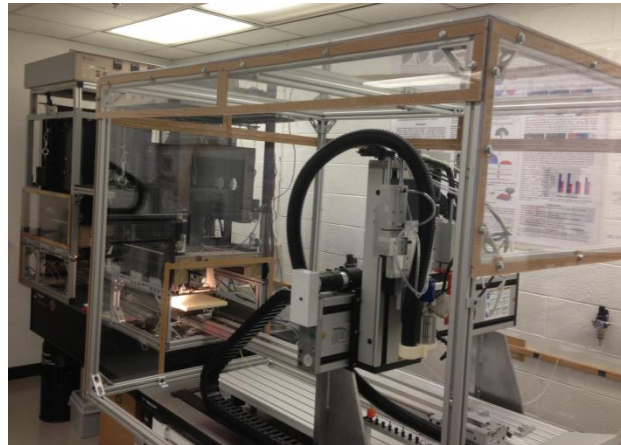

Figure 16(a). Preliminary version of hybrid fabrication system with integrated complementary manufacturing technologies.

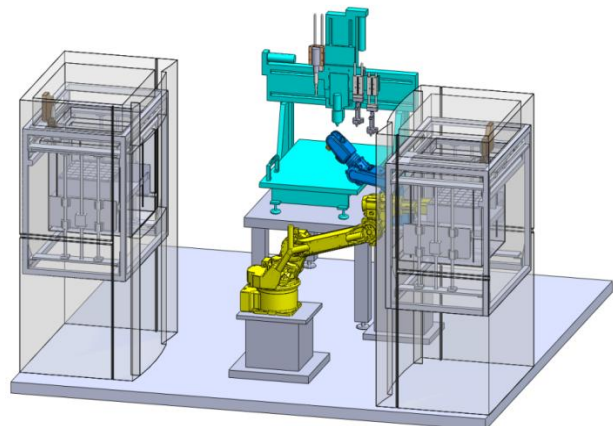

Figure 16(b). Conceptual design of the multi-function robotic system for America Makes.

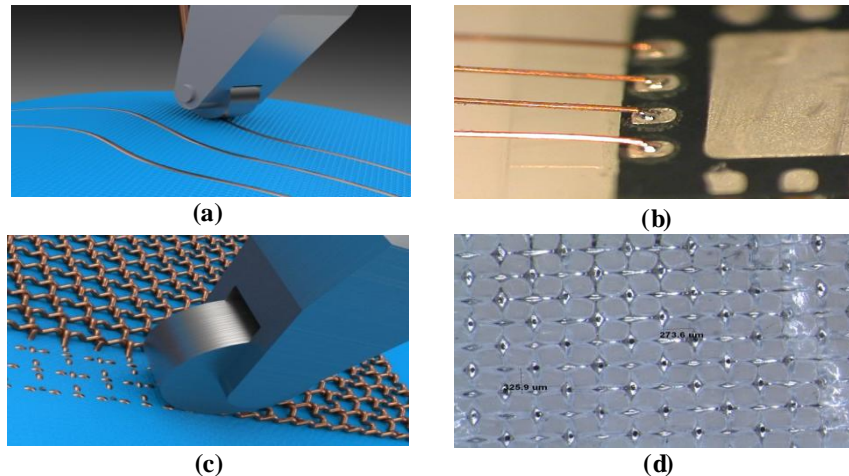

Figure 17. (a) CAD depiction of wire embedding. (b) Laser-welded component. (c) CAD depiction of embedded mesh. (d) Picture of surface after mesh embedding

The use of 3D printing to make unique electronics in complex geometric forms has been demonstrated in the past using conductive inks as interconnect.⁸⁻¹⁶ Although inks are improving, limits to curing temperatures have resulted in relatively poor performance in terms of conductivity and current carrying capacity, which is required for high-frequency and high-power applications. Recent advances in the thermal embedding wires within thermoplastic substrates have provided printed-circuit-board- (PCB-) like routing densities and performance (Fig. 17(a)) with final connections to electrical components enabled by laser welding (Fig. 17(b)). Moreover, embedded fine-pitch wire meshes can serve as either ground planes or patch antennas as shown in a Computer Aided Design depiction in Figure 17(c) and with microscopy in Figure 17(d). These meshes provide two additional benefits, volumetric reduction of the structure, and enhancement of the mechanical properties of the overall structure. Finally, by introducing meshes robustly within the polymer, novel attachment points can be created between polymer and metal components within larger systems to robustly join subsystems of disparate materials (e.g., welding polymers to metal structures).

The Commerce of Entrepreneurial Participation

No one would be surprised to learn that large Corporations like Northrop Grumman, Lockheed Martin, and Boeing have active, robust programs in additive manufacturing, as they relate to space. Many are aware that some small business have used low-end AM machines like Stratasys' Makerbots, for prototyping, but it is because entry into high-end additive manufacturing is also relatively inexpensive, that many small companies are quickly becoming significant contributors to the SmallSat market. In

addition, the materials are relatively inexpensive, the software required to produce the working files is usually free, and the time it takes to get "checked out" is measured in hours. These aspects, make it relatively straightforward to enter the AM business.

That oversimplifies entry into the market, but it is estimated that there are over 13,000 Makerbots currently in operation, which is projected to be approximately 17% of the potential market. Thus, around 70,000 3D printers are in use today with the number growing rapidly. Industry reports that 3D printer sales increased 67% in 2013 over 2012. That is still a long way from the market for 2D inkjet printers, which at about 285,000 units sold per day, is clearly a household item.

Opportunities for small business arising from 3D printing or additive manufacturing are quickly becoming apparent. Manufacture of critical aerospace and defense items typically requires significant investment, in capital equipment and quality assurance process development for example, and is largely beyond the reach of small business. As a result, small business has seen little penetration in such markets. 3D printing is changing that and is gaining interest with businesses of all sizes. Once relegated to simply producing rapid prototypes, 3D printing now represents a technology that is disruptive both in terms of its ability to produce complex items often difficult or impossible with traditional manufacturing methods and also in terms of its impact on manufacturing economics. The highly reduced capital investment, the ability to produce quantities of many items or just one, shorter development cycle and product design lead times, and the reduction in energy usage and material waste, all

translate into a lower cost of entry in markets that are increasingly under pressure to provide more for less.

Although there is a race among small business to capitalize on the 3D-printing craze, one thing that 3D printing has not eliminated is the need to innovate—something small businesses tend to be good at. For a small business to survive in the space business, it must find ways to innovate, continue to innovate, and then innovate some more as the rest of the community catches up to yesterday's good idea.

The following small businesses are just three of many such companies that use AM to exploit their innovations for space.

Case A: Made in Space. By now everyone is familiar with the plan to launch a 3D demonstration printer to the ISS, the first such manufacturing machine to be used in space. Most satellites are specifically designed to survive stressful launch loads. A SmallSat could be more efficiently optimized for the mission if it was 3D printed in space versus on Earth. With AM, we will eventually build spacecraft in space, and likely build the machines and tooling to build the spacecraft in space as well. AM opens up opportunities for a space-based manufacturing enterprise; one that not only builds the articles in space, but also mines the raw materials from asteroids, the moon, Mars...?

Case B: Cesaroni Technology in Sarasota Florida, is a high-tech company specializing in industrial design and manufacturing as well as R&D. Cesaroni understands the commerce of space and is well known for their low-cost, innovative propulsion systems for rockets. They are working with Northrop Grumman to develop low-cost access to space for the SmallSat market. Their recent acquisition of a \$3000 NextEngine 3D scanner and a \$40K Stratasys Elite printer allowed them to produce tooling parts at a fraction of the cost of traditional methods.

Case C: Printed Device Concepts, Inc. (PDC), is a small business born from innovation. PDC was founded by members of faculty and staff from our partner the UTEP Keck Center, renowned world-wide for advancements in additive manufacturing. Having been at the forefront of research in additive manufacturing and 3D electronics for over a decade, the founders of PDC recognized the potential of 3D printing, but more importantly, recognized the need to expand the capabilities of contemporary 3D printing equipment into something that could truly be called advanced manufacturing. In essence, the multi-material, multi-functional additive manufacturing approach described above was envisioned.

One of PDC's applications of 3D printing poised to revolutionize aerospace, and in particular, space hardware, is that of 3D-printed electronic, electromagnetic, and electromechanical devices. Unlike traditional electronics where a printed circuit board is created, mounted to a chassis, and then assembled into a housing manufactured with a different process, often in a different facility, 3D electronics removes the distinction between structure, housing, and circuitry. This is important for reduction of size, weight, and power (SWaP); the cost of launch into orbit (or beyond); and for allowing a greater payload. For many years, the barrier for 3D printed electronics was tied to poor choice of materials and lack of processes necessary to produce robust, high-performance hardware. PDC developed technologies to address these shortcomings and advanced 3D printing as a viable option for manufacturing space hardware. These include methods of embedding components and durable high-performance conductors and interconnections within functional 3D-printed thermoplastic structures. By continuously finding ways to innovate and maintaining a strong relationship with the Keck Center, research partners and mentor companies like Northrop Grumman Corporation, PDC will continue to grow as a key player in emerging space hardware technologies.

Summary

Successful commerce for additive manufacturing of SmallSats relies on several contributing factors: 1) a solid business model built on a growing market; 2) cooperation among the stakeholders whether they are large or small businesses, universities, or Government organizations; and 3) an innovative spirit applied to a common goal of advancing technology to solve difficult problems with affordable solutions. The team described in this paper understands that and is aggressively progressing on key technologies to develop a complete 3D-printed SmallSat.

References

1. Brian Horais, Lonnie Love, Ryan Dehoff, "The Use of Additive Manufacturing for Fabrication of Multi Function Small Satellite Structures", SSC-III-6, SmallSat Conference Aug. 2013.
2. Guerrero, J., et al., AIAA Space Proceedings presentation on Multifunctional Structures, AIAA-2001-4585, 408–413, 2001.
3. Carpenter, C. B., Schmuland, D., Overly, J., and Masse, R., "CubeSat Modular Propulsion Systems Product Line Development Status and Mission Applications", AIAA 2013-3760, 49th AIAA/ASME/SAE/ASEE Joint Propulsion Conference & Exhibit, San Jose, CA, 14-17 July 2013.

4. Conversano, R. W. and Wirz, R. E., "Mission Capability Assessment of CubeSats Using Miniature Ion Thruster", *Journal of Spacecraft and Rockets*, Vol. 50, No. 5, September-October 2013.
5. Within Labs. "Heat exchanger case study: Heralding a new era in engineering design." <http://www.within-lab.com/case-studies/index11.php>
6. "Staying Cool on the ISS", *NASA Science News*, 2001. http://science.nasa.gov/science-news/science-at-nasa/2001/ast21mar_1/
7. Abe Hertzberg, "Thermal Management in Space," in *Space Resources: Energy, Power, and Transport*, Editors Mary Fae McKay, David S. McKay, and Michael B. Duke, NASA SP-509, 1992. <http://www.nss.org/settlement/nasa/spaceresvol2/thermalmanagement.html>
8. R. B. Wicker and E.W. MacDonald, "Multi-Material, Multi-Technology Stereolithography," *Virtual and Physical Prototyping*, Volume 7, Number 3, 2012, pages 181-194.
9. A. Lopes, E. MacDonald, and R.B. Wicker, "Integrating Stereolithography and Direct Print Technologies for 3D Structural Electronics Fabrication," *Rapid Prototyping Journal*, Volume 18, Issue 2, 2012, pages 129-143.
10. D. Roberson, R. Wicker, E. MacDonald, "Microstructural Characterization of Electrically Failed Conductive Traces Printed from Ag nanoparticles", *Journal of Electronic Materials*, 2012.
11. E. DeNava, M. Navarrete, E. MacDonald and R. Wicker, "Three-Dimensional Off-Axis Component Placement and Routing for Electronics Integration using Solid Freeform Fabrication," *Solid Freeform Fabrication Symposium*, 2008.
12. M. Navarrete, A. Lopes, J. Acuna, R. Estrada, R. MacDonald, J. Palmer, and R. Wicker, "Integrated Layered Manufacturing of a Novel Wireless Motion Sensor System with GPS," *Solid Freeform Fabrication Symposium* 2007.
13. Mireles, J., 2013. Development of a Fused Deposition Modeling System for Low Melting Temperature Metal Alloys. *Journal of Electronic Packaging*, 135 (1), 011008.
14. A. J. Lopes, I. H. Lee, E. MacDonald, R. Quintana, and R. Wicker, "Laser Curing of Silver-Based Conductive Inks for In Situ 3D Structural Electronics Fabrication in Stereolithography", *Journal Materials Processing Technology*, submitted in February, 2014.
15. MacDonald, E.; Salas, R.; Espalin, D.; Perez, M.; Aguilera, E.; Muse, D.; Wicker, R., "3D Printing for the Rapid Prototyping of Structural Electronics," *Access IEEE*, no.99, pp. 1-12.
16. D. Espalin, D. Muse, F. Medina, E. MacDonald, and R.B. Wicker, "3D Printing Multi-Functionality: Structures with Electronics," *International Journal of Advanced Manufacturing Technology*, submitted June 2013.